

# EN

**INSTRUCTIONS**  
MATERIAL MOISTURE  
MEASURING DEVICE  
CONTROLLED VIA SMARTPHONE



**Table of contents**

**Information on the use of these instructions** ..... 2

**Safety** ..... 2

**Information about the device** ..... 4

**Transport and storage** ..... 5

**Operation** ..... 5

**Measuring principle** ..... 17

**Maintenance and repair** ..... 18

**Errors and faults** ..... 18

**Disposal** ..... 19

**Declaration of conformity** ..... 19

**Information on the use of these instructions**

**Symbols**



**Warning of electrical voltage**

This symbol indicates dangers to the life and health of persons due to electrical voltage.



**Warning**

This signal word indicates a hazard with an average risk level which, if not avoided, can result in serious injury or death.



**Caution**

This signal word indicates a hazard with a low risk level which, if not avoided, can result in minor or moderate injury.

**Notice**

This signal word indicates important information (e.g. material damage), but does not indicate hazards.



**Info**

Information marked with this symbol helps you to carry out your tasks quickly and safely.



**Follow the manual**

Information marked with this symbol indicates that the instructions must be observed.

You can download the current version of the instructions and the EU declaration of conformity via the following link:



BM31WP



<https://hub.trotec.com/?id=43336>

**Safety**

**Read this manual carefully before starting or using the device. Always store the manual in the immediate vicinity of the device or its site of use.**



**Warning**

**Read all safety warnings and all instructions.**

Failure to follow the warnings and instructions may result in electric shock, fire and/or serious injury.

**Save all warnings and instructions for future reference.**

- Do not use the device in potentially explosive rooms or areas and do not install it there.
- Do not use the device in an aggressive atmosphere.
- Do not immerse the device in water. Do not allow liquids to penetrate into the device.
- The device may only be used in dry surroundings and must not be used in the rain or at a relative humidity exceeding the operating conditions.
- Protect the device from permanent direct sunlight.
- Do not expose the device to strong vibrations.
- Do not open the device.
- Do not remove any safety signs, stickers or labels from the device. Keep all safety signs, stickers and labels in legible condition.
- Use batteries of type AAA.
- Never charge batteries that cannot be recharged.
- Different types of batteries and new and used batteries must not be used together.
- Insert the batteries into the battery compartment according to the correct polarity.
- Remove discharged batteries. Batteries contain materials hazardous to the environment. Dispose of the batteries according to the national regulations.
- Remove the batteries from the device if you will not be using the device for a longer period of time.
- Never short-circuit the supply terminal in the battery compartment!

- Do not swallow batteries! If a battery is swallowed, it can cause severe internal burns within 2 hours! These burns can lead to death!
- If you think batteries might have been swallowed or otherwise entered the body, seek medical attention immediately!
- Keep new and used batteries and an open battery compartment away from children.
- Observe the storage and operating conditions (see Technical data).

### Intended use

Use this device in combination with a terminal device that is compatible with the installed Trotec MultiMeasure Mobile app.

Only use the device for moisture measurements of wood and building materials within the measuring range specified in the technical data.

The Trotec MultiMeasure Mobile app on the terminal device is used for both operation and the evaluation of the measured values.

Data logged by the device can be displayed, saved or transmitted either numerically or in form of a chart.

Any use other than the intended use is regarded as misuse.

### Reasonably foreseeable misuse

Do not use the device in potentially explosive atmospheres, for measurements in liquids or on live parts.

Radio waves may interfere with the operation of medical equipment and cause malfunctions. Do not use the device near medical equipment or within medical institutions.

Persons with pacemakers must observe a minimum distance of 20 cm between the pacemaker and the device.

Also do not use the device near automatically controlled systems such as alarm systems and automatic doors. Radio waves may interfere with the operation of such equipment and cause malfunctions. Make sure that no other devices are malfunctioning during the use of your device.

Any unauthorised changes, modifications or alterations to the device are forbidden.

### Personnel qualification

People who use this device must:

- have read and understood the instructions, especially the Safety chapter.

### Residual risks



#### Warning of electrical voltage

There is a risk of a short-circuit due to liquids penetrating the housing!

Do not immerse the device and the accessories in water. Make sure that no water or other liquids can enter the housing.



#### Warning of electrical voltage

Work on the electrical components must only be carried out by an authorised specialist company!



#### Warning

Risk of suffocation!

Do not leave the packaging lying around. Children may use it as a dangerous toy.



#### Warning

The device is not a toy and does not belong in the hands of children.



#### Warning

Dangers can occur at the device when it is used by untrained people in an unprofessional or improper way! Observe the personnel qualifications!



#### Caution

Keep a sufficient distance from heat sources.

#### Notice

To prevent damages to the device, do not expose it to extreme temperatures, extreme humidity or moisture.

#### Notice

Do not use abrasive cleaners or solvents to clean the device.

**Information about the device**

**Device description**

Used in combination with Trotec's MultiMeasure Mobile app the material moisture measuring device permits material moisture measurements of surfaces, especially screeds.

In case of a matrix measurement the measured values can be displayed two-dimensionally (XY-diagram) with a background image or grid.

The measurement results can be displayed and saved on the terminal device either numerically or in form of a chart. Then, the measurement data can be sent in PDF or Excel format.

The app also includes a report generation function, an organiser function, one for customer management and further analysis options. Moreover, it is possible to share measurements and project data with colleagues in another subsidiary.

If MultiMeasure Studio Professional is installed on a PC, you can even use report templates and ready-made text blocks for various fields of application to turn the data into professional reports.

**Device depiction**

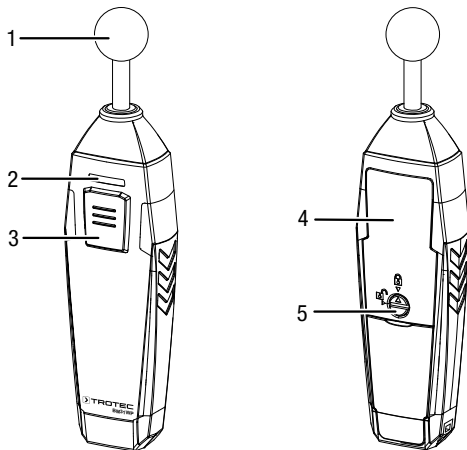

No.	Designation
1	Measuring sensor
2	LED
3	On / off / measurement button
4	Battery compartment with cover
5	Lock

**Technical data**

Parameter	Value
Model	BM31WP
Measuring principle	capacitive / dielectric measurement method
Measuring range	0 to 100 digits
Measuring range resolution	0.1 digit
Penetration depth	40 mm
<b>General technical data</b>	
Bluetooth standard	Bluetooth 4.0, Low Energy
Bluetooth frequency range	2.4 GHz
Bluetooth max. transmission power	10 dBm
Radio range	approx. 10 m (depending on measuring environment)
Operating temperature	0 °C to 50 °C
Power supply	2 x 1.5 V batteries, type AAA
Device switch-off	after approx. 3 minutes without active Bluetooth connection
Protection type	IP40
Weight	approx. 93 g
Dimensions (length x width x height)	22 mm x 36 mm x 160 mm

**Scope of delivery**

- 1 x Device BM31WP (without batteries)
- 1 x Wrist strap
- 1 x Quick guide

## Transport and storage

### Notice

If you store or transport the device improperly, the device may be damaged.

Note the information regarding transport and storage of the device.

### Transport

When transporting the device, ensure dry conditions and protect the device from external influences e.g. by using a suitable bag.

### Storage

When the device is not being used, observe the following storage conditions:

- dry and protected from frost and heat
- protected from dust and direct sunlight
- at the temperature specified in the technical data
- Batteries are removed from the device

## Operation

### Inserting the batteries

#### Notice

Make sure that the surface of the device is dry and the device is switched off.

1. Unlock the battery compartment by turning the lock (5) in a way that the arrow points towards the opened padlock icon.
2. Remove the cover from the battery compartment (4).
3. Insert the batteries (2 batteries of type AAA) into the battery compartment with correct polarity.
4. Put the cover back onto the battery compartment.
5. Lock the battery compartment by turning the lock (5) in a way that the arrow points towards the closed padlock icon.

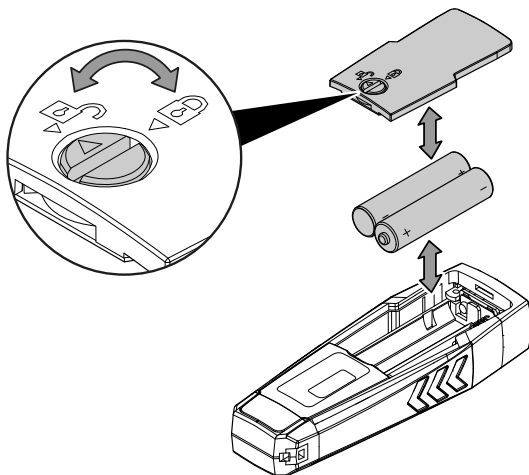

### MultiMeasure Mobile app



Install the Trotec MultiMeasure Mobile app on the terminal device you want to use in combination with the device.

#### Info

Some of the app's functions require access to your location and an active Internet connection.

The app is available for download in the Google Play Store as well as in Apple's app store and via the following link:



<https://hub.trotec.com/?id=43083>

#### Info

Allow for an acclimatization period of about 10 minutes in the respective measuring environment prior to the appSensor's measuring operation.

## Connecting the appSensor

### Info

The app can simultaneously be connected to several different appSensors or appSensors of the same type and also record several measurements at the same time.

Proceed as follows to connect the appSensor to the terminal device:

- ✓ The Trotec MultiMeasure Mobile app is installed.
- ✓ The Bluetooth function on your terminal device is activated.
- 1. Start the Trotec MultiMeasure Mobile app on the terminal device.
- 2. Briefly actuate the *On / off / measurement* button (3) three times to switch on the appSensor.
  - ⇒ The LED (2) flashes yellow.
- 3. Press the *Sensors* button (6) on the terminal device.
  - ⇒ The sensors overview opens.
- 4. Press the *Refresh* button (7).
  - ⇒ If the scanning mode was not active before, the colour of the *Refresh* button (7) will change from grey to black. The terminal device now scans the surroundings for all available appSensors.
- 5. Press the *Connect* button (8) to connect the desired sensor to the terminal device.
  - ⇒ The LED (2) flashes green.
  - ⇒ The appSensor is connected to the terminal device and starts measuring.
  - ⇒ The on-screen display changes to the continuous measurement.

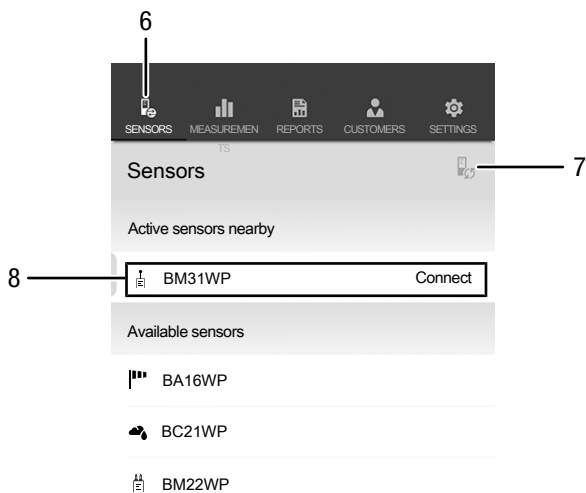

## Calibrating the sensor

After switch-on the sensor needs to be recalibrated to the respective surrounding conditions of measuring location. This is an automatic process starting when the sensor is connected to the app after switch-on.

1. Hold the sensor preferably somewhere near the bottom and in one hand (corrugated rubber coating).
2. Point the measuring device away from the body and any objects into clear space.

If the sensor displays incorrect values or you have changed its position during the measurement, you can manually initiate another calibration process (see Measurement settings).

## Selecting material

Before you carry out a measurement you should select the material to be measured. To do so, please proceed as follows:

1. Press the *Menu* button (11).
  - ⇒ The context menu opens.
2. Press the *Sensor settings* button (15).
  - ⇒ The sensor settings menu opens.

Via the menu item *Features* you can choose from the following:

- Building moisture anhydrite
- Building moisture cement

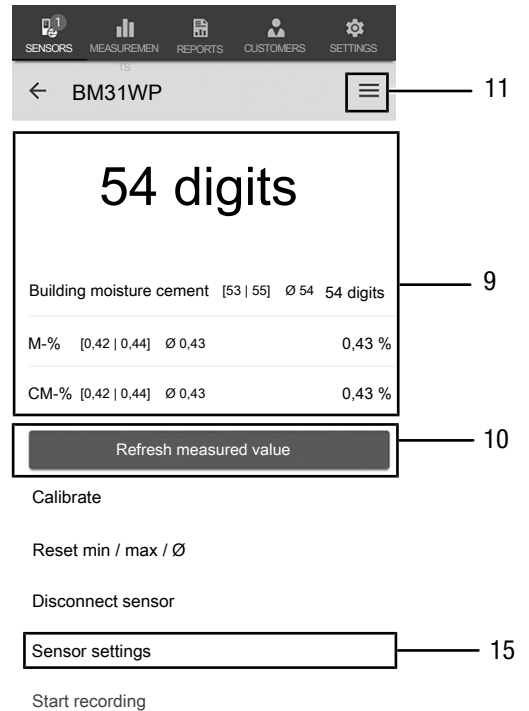

No.	Designation	Meaning
6	<i>Sensors</i> button	Opens the sensors overview
7	<i>Refresh</i> button	Refreshes the list of sensors near the terminal device
8	<i>Connect</i> button	Connects the displayed sensor to the terminal device

No.	Designation	Meaning
9	Numeric <i>value</i> display	<p><b>Current value:</b> Indicates the currently determined value in digits without unit.</p> <p><b>Building moisture anhydrite / cement:</b> Indicates the minimum, maximum and average values as well as the current moisture value in digits without unit (material selection via sensor settings).</p> <p><b>M-%:</b> Indicates the minimum, maximum and average values as well as the calculated M moisture value.</p> <p><b>CM-%:</b> Indicates the minimum, maximum and average values as well as the calculated CM moisture value.</p>
10	<i>Refresh measured value</i> button	Performs an individual measurement and refreshes the displayed values
11	<i>Menu</i> button	Opens the menu for making settings for the current measurement.
15	<i>Sensor settings</i> button	Opens the settings menu for the connected appSensor

### Carrying out a measurement

Put the sensor at a right angle completely on the material to be measured and observe a minimum distance of 8 to 10 cm to corners.



#### Info

Please note that the displayed values are merely rough reference values which cannot replace mandatory CM measurements. Since, particularly in case of mineral building materials, the measurement results can be influenced by salinization as well as chemical additives, the determined values shall only be used as an indicator of near-surface material moisture, not for an absolute assessment.



#### Info

Note that moving from a cold area to a warm area can lead to condensation forming on the device's circuit board. This physical and unavoidable effect can falsify the measurement. In this case, the app will either display incorrect measured values or none at all. Wait a few minutes until the device has become adjusted to the changed conditions before carrying out a measurement.

### Individual value measurement

When the appSensor has been successfully connected to the terminal device, an individual value measurement is started and the first determined value will be indicated.

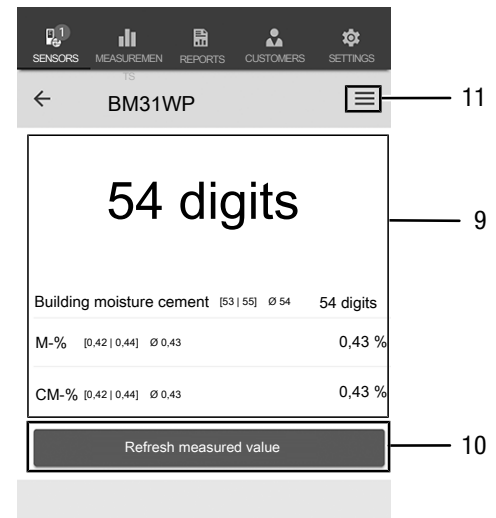

No.	Designation	Meaning
9	Numeric <i>value</i> display	<p><b>Current value:</b> Indicates the currently determined value in digits without unit.</p> <p><b>Building moisture anhydrite / cement:</b> Indicates the minimum, maximum and average values as well as the current moisture value in digits without unit (material selection via sensor settings).</p> <p><b>M-%:</b> Indicates the minimum, maximum and average values as well as the calculated M moisture value.</p> <p><b>CM-%:</b> Indicates the minimum, maximum and average values as well as the calculated CM moisture value.</p>
10	<i>Refresh measured value</i> button	Performs an individual measurement and refreshes the displayed values
11	<i>Menu</i> button	Opens the menu for making settings for the current measurement.

### Refreshing the measured value

Proceed as follows to refresh the measured values in the individual value measurement mode:

1. Press the *Refresh measured value* button (10) on the terminal device.
  - ⇒ The appSensor determines the current measured value which is then displayed on the terminal device.
2. You can also press the *On / off / measurement* button (3) on the appSensor.
  - ⇒ The appSensor determines the current measured value which is then displayed on the terminal device.

**Measurement settings**

Proceed as follows to adjust the settings for the measurement:

1. Press the *Menu* button (11) or the free area below the measured value display.  
⇒ The context menu opens.
2. Adjust the settings as required.

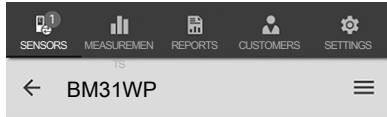

54 digits

Building moisture cement [53 | 55] Ø 54 54 digits  
 M-% [0,42 | 0,44] Ø 0,43 0,43 %  
 CM-% [0,42 | 0,44] Ø 0,43 0,43 %

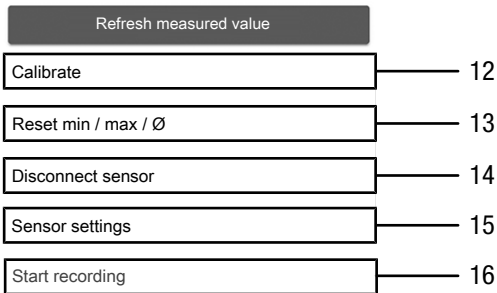

No.	Designation	Meaning
12	<i>Calibrate</i> button	Calibrates the connected appSensor.
13	<i>Reset min / max / Ø</i> button	Deletes the determined values
14	<i>Disconnect sensor</i> button	Disconnects the connected appSensor from the terminal device
15	<i>Sensor settings</i> button	Opens the settings menu for the connected appSensor
16	<i>Start recording</i> button	Starts a recording of the determined measured values for later evaluation

**Recording measured values**

Proceed as follows to record measured values for later evaluation:

1. Press the *Menu* button (11).  
⇒ The context menu opens.
2. Press the *Start recording* button (16).  
⇒ A menu listing different measurement methods will be displayed:
  - individual spot measurement without image
  - individual spot measurement with image
  - Matrix measurement without background image
  - Matrix measurement with background image
3. Select one of the measurement methods by tapping the respective button on the terminal device.

If you select one of the measurement methods, you will be redirected to the respective submenu and the *REC* button (17) will displayed instead of the *Menu* button (11).

**Performing an individual spot measurement without image**

The individual spot measurement without image allows you to record several individual measuring points. To do so, please proceed as follows:

1. Repeatedly press the *On / off / measurement* button (3) on the appSensor or the *Refresh measured value* button (10) on the terminal device until you have logged all the required measured values.

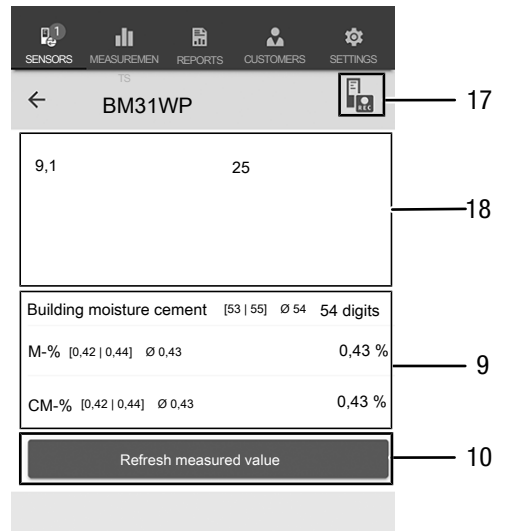



No.	Designation	Meaning
9	Numeric <i>value</i> display	<b>Building moisture anhydrite / cement:</b> Indicates the minimum, maximum and average values as well as the current moisture value in digits without unit (material selection via sensor settings). <b>M-%:</b> Indicates the minimum, maximum and average values as well as the calculated M moisture value. <b>CM-%:</b> Indicates the minimum, maximum and average values as well as the calculated CM moisture value.
10	<i>Refresh measured value</i> button	Performs an individual measurement and refreshes the displayed values
17	<i>REC</i> button	Opens the context menu for sensors
18	Measurement series indication	<b>Measured values:</b> Indicates the measured values of the measurement series in digits without unit.

### Performing an individual spot measurement with image

If you have selected individual spot measurement with image, you will be prompted to choose whether you want to use a photo already saved in the mobile device's gallery or take a new one directly in the app. Choose an image section that best matches the measuring surface.

For measured value data logging please proceed as follows:

1. Tap the screen at the exact measuring location. The measured value will be displayed at this location.
2. You can also press the *On / off / measurement* button (3) on the appSensor.  
⇒ The measured value will be displayed in a specified grid on the background image. Pressing the *Shift measuring point* button (20) allows you to adjust the position of the measuring points. By pressing the *Shift measuring point* button (20) once more you can return to the measuring mode.

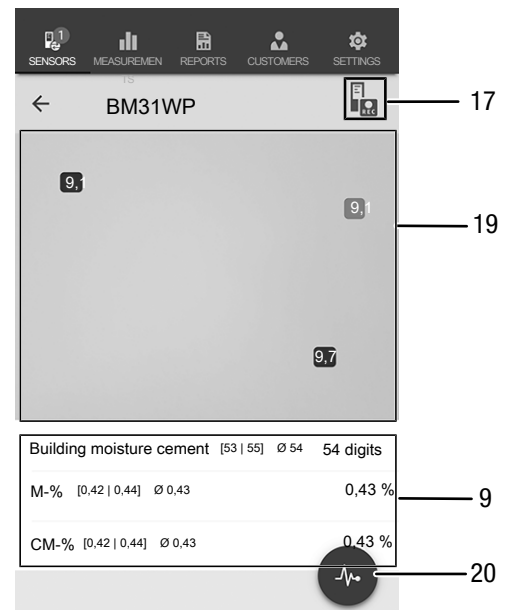

No.	Designation	Meaning
9	Numeric <i>value</i> display	<b>Building moisture anhydrite / cement:</b> Indicates the minimum, maximum and average values as well as the current moisture value in digits without unit (material selection via sensor settings). <b>M-%:</b> Indicates the minimum, maximum and average values as well as the calculated M moisture value. <b>CM-%:</b> Indicates the minimum, maximum and average values as well as the calculated CM moisture value.
17	<i>REC</i> button	Opens the context menu for sensors
19	Measuring field indication	Indicates the image of the measuring field and the values measured at the measuring points
20	<i>Shift measuring point</i> button	Stops the measured value data logging and allows you to relocate the measuring points on the background image

**Performing a matrix measurement without background image**

In case of a matrix measurement an entire series of measuring points is captured using a grid the size of which has to be selected.

1. Always start a matrix measurement in the top left corner (1st row, 1st column).  
⇒ The grid field to be measured flashes.
2. Perform the measurement in the flashing grid field.
3. Confirm the measured value by pressing the *Measured value data logging* button (22). You can reset a logged value by pressing *UNDO* (23). You can skip the indicated grid field and continue with the measurement in the next by pressing the *SKIP* button (24).  
⇒ The displayed measurement grid (21) moves on to the next line.
4. Perform the next measurement at the given point.
5. Press *NEW COLUMN* (25) when you have completed the measurements of all lines in one column so as to move on to the next.

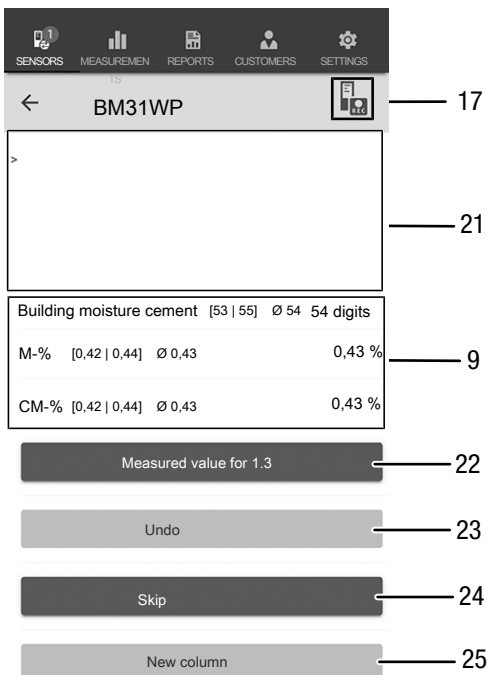

No.	Designation	Meaning
9	Numeric value display	<b>Building moisture anhydrite / cement:</b> Indicates the minimum, maximum and average values as well as the current moisture value in digits without unit (material selection via sensor settings). <b>M-%:</b> Indicates the minimum, maximum and average values as well as the calculated M moisture value. <b>CM-%:</b> Indicates the minimum, maximum and average values as well as the calculated CM moisture value.
17	REC button	Opens the context menu for sensors
21	Measuring field with grid	Indicates the measurement grid of the measuring field (grid field to be measured flashes red)
22	Measured value data logging button	Saves the measured value for the flashing grid field
23	UNDO button	Deletes the saved measured value for the respective grid field
24	SKIP button	Skips the grid field flashing red and moves on to the next grid field
25	NEW COLUMN button	Starts a new column

## Performing a matrix measurement with background image

If you select a matrix measurement with background image, you will be prompted to choose whether you want to use a photo already saved in the mobile device's gallery or take a new one directly in the app. Choose an image section that best matches the measuring surface. You will then reach the settings menu for the measurement grid (21).

1. Adjust the grid's number of columns and lines by use of the slider (26).
2. Confirm the settings for the grid by pressing *Use* (27).

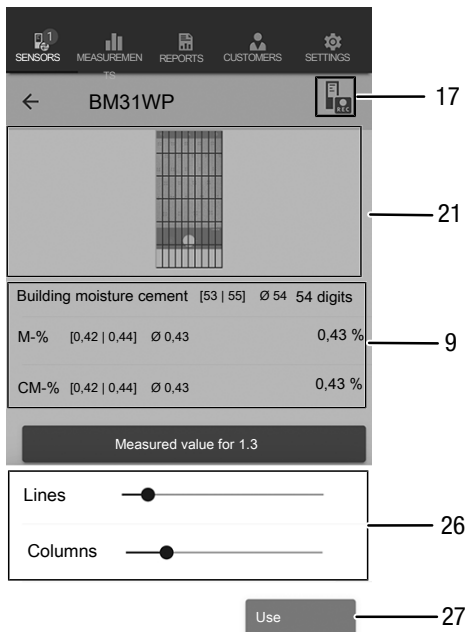

Then start to carry out the measurements.

1. Always start a matrix measurement in the top left corner (1st row, 1st column).  
⇒ The grid field to be measured flashes.
2. Perform the measurement in the flashing grid field.
3. Confirm the measured value by pressing the *Measured value data logging* button (22). You can reset a logged value by pressing *UNDO* (23). You can skip the indicated grid field and continue with the measurement in the next by pressing the *SKIP* button (24).  
⇒ The displayed measurement grid (21) moves on to the next line.
4. Perform the next measurement at the given point.

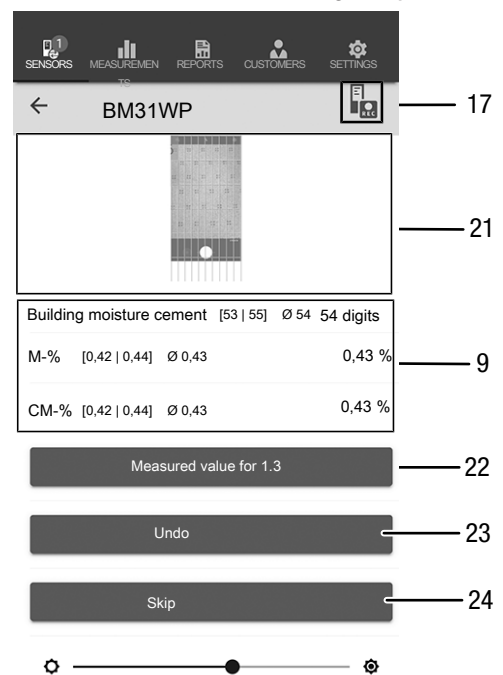

### Info

By use of the slider you can optionally bring out either the background image or the grid.

No.	Designation	Meaning
9	Numeric value display	<p><b>Building moisture anhydrite / cement:</b> Indicates the minimum, maximum and average values as well as the current moisture value in digits without unit (material selection via sensor settings).</p> <p><b>M-%:</b> Indicates the minimum, maximum and average values as well as the calculated M moisture value.</p> <p><b>CM-%:</b> Indicates the minimum, maximum and average values as well as the calculated CM moisture value.</p>
17	REC button	Opens the context menu for sensors
21	Measuring field with grid	Indicates the measurement grid of the measuring field (with or without background image).
26	Slider	Changes the grid's number of columns and lines
27	Use button	Confirms the settings and leads to the measurement menu.

No.	Designation	Meaning
9	Numeric <i>value</i> display	<p><b>Building moisture anhydrite / cement:</b> Indicates the minimum, maximum and average values as well as the current moisture value in digits without unit (material selection via sensor settings).</p> <p><b>M-%:</b> Indicates the minimum, maximum and average values as well as the calculated M moisture value.</p> <p><b>CM-%:</b> Indicates the minimum, maximum and average values as well as the calculated CM moisture value.</p>
17	<i>REC</i> button	Opens the context menu for sensors
21	Measuring field with grid	Indicates the measurement grid of the measuring field (grid field to be measured flashes red)
22	<i>Measured value data logging</i> button	Saves the measured value for the flashing grid field
23	<i>UNDO</i> button	Deletes the saved measured value for the respective grid field
24	<i>SKIP</i> button	Skips the grid field flashing red and moves on to the next grid field

### Stopping a recording

Proceed as follows to stop recording the measured values:

1. Press the *REC* button (17).  
⇒ The context menu for sensors opens.
2. Press the *Stop recording* button (28).  
⇒ The context menu for saving the recording opens.
3. You can optionally save, discard or resume the measurement.

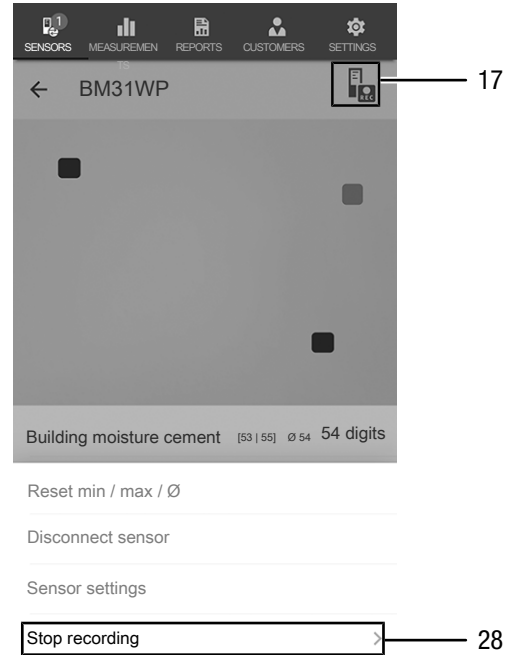

No.	Designation	Meaning
17	<i>REC</i> button	Opens the sensor settings menu.
28	<i>Stop recording</i> button	Stops the current recording of measured values. Opens the submenu for saving recordings.

## Saving a recording

Proceed as follows to save the recorded measured values:

1. Press the *Save* button (29) to save the recorded measured values on the terminal device.
  - ⇒ The input mask for logging the recorded data opens.
2. Enter all the data relevant for an unambiguous assignment, then save the recording.
  - ⇒ The recording will be saved on the terminal device.

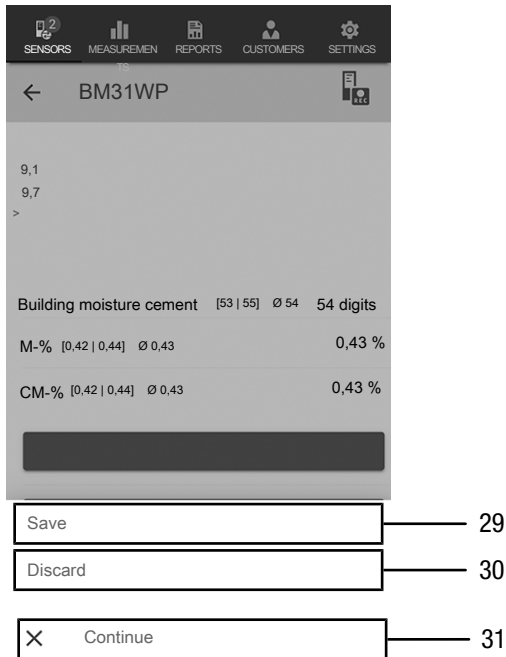

No.	Designation	Meaning
29	<i>Save</i> button	Stops the current recording of measured values. Opens the input mask for logging recording data.
30	<i>Discard</i> button	Stops the current recording of measured values. Discards the recorded measured values.
31	<i>Continue</i> button	Resumes the recording of the measured values without saving.

## Analysing measurements

Proceed as follows to call up the saved measurements:

1. Press the *MEASUREMENTS* button (32).
  - ⇒ An overview of already saved measurements will be displayed.
2. Press the *Display measurement* button (34) for the desired measurement to be indicated.
  - ⇒ A context menu for the selected measurement opens.

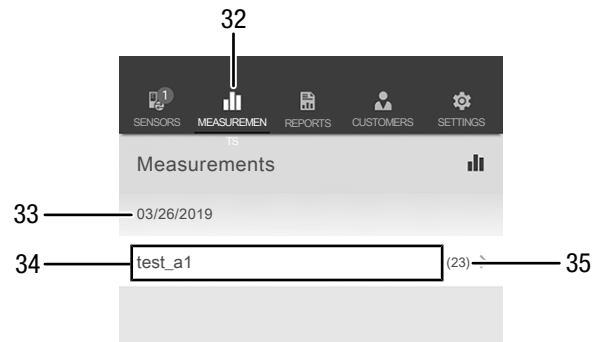

No.	Designation	Meaning
32	<i>MEASUREMENTS</i> button	Opens the overview of saved measurements.
33	Indication of the <i>date of the measurement</i>	Indicates the date on which the measurement was recorded.
34	<i>Display measurement</i> button	Opens the context menu for the selected measurement.
35	Indication of the <i>number of measured values</i>	Indicates the number of individual measured values constituting the saved measurement.

The following functions can be called up in the context menu of the selected measurement:

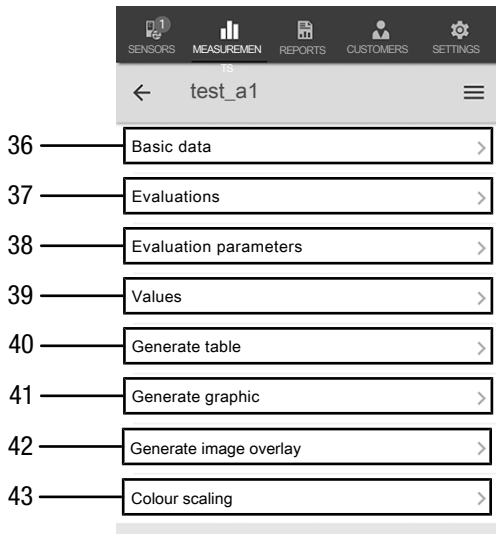

No.	Designation	Meaning
36	<i>Basic data</i> button	Opens an overview of the data saved for the measurement.
37	<i>Evaluations</i> button	Opens an overview of the evaluations generated for the measurement (graphics and tables).
38	<i>Evaluation parameters</i> button	Opens a menu to select and deselect individual evaluation parameters.
39	<i>Values</i> button	Opens a tabular overview of all logged values for the measurement.
40	<i>Generate table</i> button	Creates a table containing the logged values of the measurement and saves it as a *.CSV file.
41	<i>Generate graphic</i> button	Creates a graphic representation of the logged values and saves it as a *.PNG file.
42	<i>Generate image overlay</i> button	Combines a background image with the coloured representation of the measured moisture values.
43	<i>Colour scaling</i> button	Allows you to adjust the colour display of the measured moisture values.

### Generating a report

The reports generated in the MultiMeasure Mobile app are short reports providing a fast and simple documentation. Proceed as follows to generate a new report:

1. Press the *REPORTS* button (44).  
⇒ The reports overview opens.
2. Press the *New report* button (45) to create a new report.  
⇒ An input mask for entering all the relevant information opens.
3. Enter the information via the input mask and save the data.

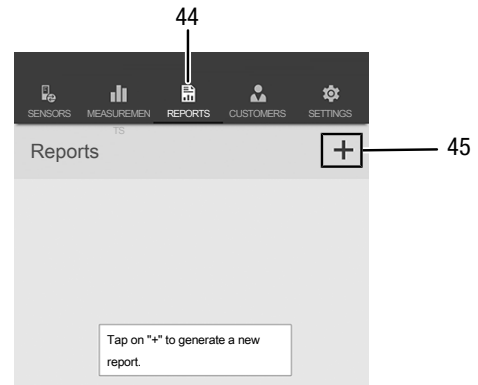

No.	Designation	Meaning
44	<i>REPORTS</i> button	Opens the overview of saved reports.
45	<i>New report</i> button	Creates a new report and opens the input mask.

#### Info

The customer can acknowledge the report directly in the integrated signature field.

### Calling up a report

Proceed as follows to call up a created report:

1. Press the *REPORTS* button (44).  
⇒ The reports overview opens.
2. Press the corresponding button (46) to display the desired report.  
⇒ An input mask opens in which you can view and edit all the information.

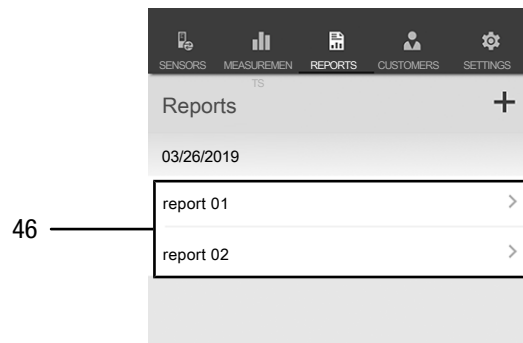

No.	Designation	Meaning
46	<i>Display REPORT</i> button	Opens the selected report.

## Creating a new customer

Proceed as follows to create a new customer:

1. Press the *CUSTOMERS* button (47).  
⇒ The customers overview opens.
2. Press the *New customer* button (48) to create a new customer.  
⇒ An input mask for entering all the relevant information opens.
3. Enter the information via the input mask and save the data.
4. Alternatively, you can also import existing contacts from the phone book of the terminal device.

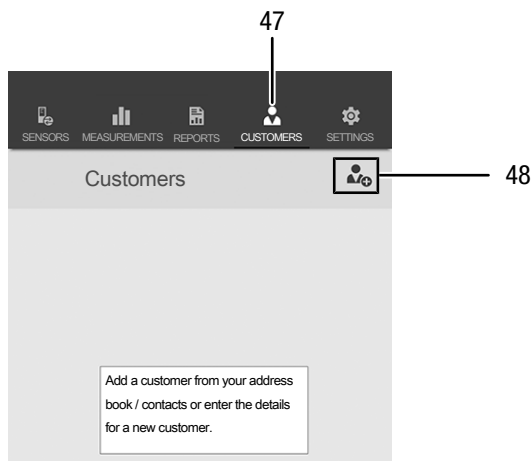

No.	Designation	Meaning
47	<i>CUSTOMERS</i> button	Opens the overview of saved customers.
48	<i>Add customer</i> button	Creates a new customer and opens the input mask.

### Info

You can perform a new measurement directly from the input mask.

## Calling up customers

Proceed as follows to call up an already created customer:

1. Press the *CUSTOMERS* button (47).  
⇒ The customers overview opens.
2. Press the corresponding button (49) to display the desired customer's details.  
⇒ An input mask opens in which you can view and edit all the information for the selected customer as well as directly start a new measurement.  
⇒ The *New customer* button (48) changes. In this menu it can be used to delete the selected customer data record.

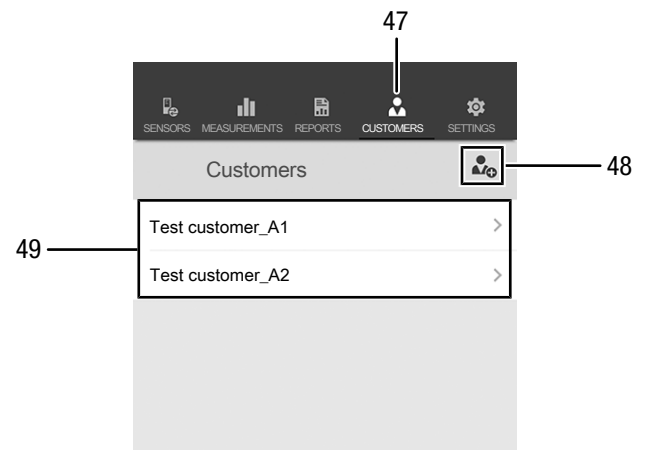

No.	Designation	Meaning
47	<i>CUSTOMERS</i> button	Opens the overview of saved customers.
48	<i>Add customer</i> button	allows you to delete the selected customer data record
49	<i>Customer X</i> button	opens the input mask for reading and changing the information for a saved customer

**App settings**

Proceed as follows to make settings in the Trotec MultiMeasure Mobile app:

1. Press the *SETTINGS* button (50).  
⇒ The settings menu opens.
2. Adjust the settings as required.

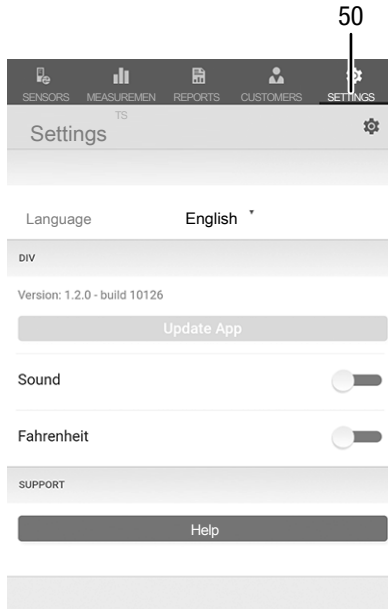

No.	Designation	Meaning
50	SETTINGS button	opens the overview for the app settings and information

**appSensor settings**

Proceed as follows to adjust the settings for the appSensor:

1. Press the *Sensors* button (6).  
⇒ A list of connected and available sensors will be displayed.
2. Select the line with the appSensor the settings of which you want do adjust and swipe right at the yellow marking.
3. Confirm your input.  
⇒ The sensor menu opens.
4. Alternatively, you can press the *Sensors* button (6).
5. Press the *Menu* button (11).  
⇒ The context menu opens.
6. Press the *Sensor settings* button (15).  
⇒ The sensor menu opens.

**Disconnecting an appSensor**

Proceed as follows to disconnect an appSensor from the terminal device:

1. Press the *Sensors* button (6).  
⇒ A list of connected and available sensors will be displayed.
2. Select the line with the appSensor to be disconnected and swipe left at the red marking.
3. Confirm your input.  
⇒ The appSensor is now disconnected from the terminal device and can be switched off.
4. Alternatively, you can press the *Menu* button (11).  
⇒ The context menu opens.
5. Press the *Disconnect sensor* button (14).
6. Confirm your input.  
⇒ The appSensor is now disconnected from the terminal device and can be switched off.

**Switching off an appSensor**

**Info**

Always terminate the connection between appSensor and app before you switch off the appSensor.

Proceed as follows to switch off an appSensor:

1. Press and hold the *On / off / measurement* button (3) for approx. 3 seconds.  
⇒ The LED (2) on the appSensor goes out.  
⇒ The appSensor is switched off.
2. You may now exit the Trotec MultiMeasure Mobile app on the terminal device.



## Measuring principle

The measuring device at hand serves for the rough determination of the material or wood moisture content according to the dielectric measuring principle. Fields of application include the non-destructive moisture measurement of sawn timber, lumber and firewood as well as of mineral building materials.

The dielectric measuring method is an indirect measurement method, since the moisture content of the measured material is deduced from the changed dielectric permittivity.

Influencing variables suitable to change this parameter, e.g. electrically conducting materials or dissolved salts, hence also have a direct influence on the determined measured values. Since the exact composition of building materials is generally unknown before a moisture measurement, the displayed measured values can only be regarded as an indicator of the moisture content.

### General notes on use

Calibration curves for measuring the moisture level in different mineral building materials, hardwood, softwood and chipboard are stored in the device. If precise material moisture values are required, an additional control measurement applying the Darr procedure is recommended. Especially for precise wood moisture measurements for other wood temperatures or with due regard to the type and bulk density of a certain timber it is recommended to use a wood moisture measuring device with temperature comparison function and selection option for the specific wood type calibration.

- When selecting the measuring positions observe the following:
  - Always measure the material moisture at three different positions in order to achieve a sufficient accuracy by means of the arithmetic average.
  - Do not measure the face, because there are mainly dry areas.
  - Preferably do not measure at cracks, branches or resin pockets either.
- The measurement results are only to be used as reference for a rough orientation.
- The height of the measured value can be calculated from the determined dielectric constant of the measured material. Dry air has a constant of 1, water 80. Hence, the more humidity is contained in the material, the higher will be the displayed measured value.
- Another important variable influencing the measured value is the bulk density of the good to be measured. The higher the bulk density, the higher the measured value.

## Notes on use regarding the material moisture measurement

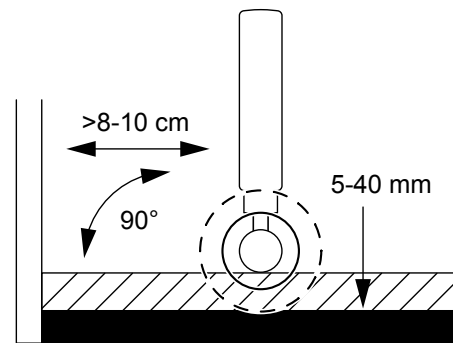

No further settings are required for the quick determination of the material moisture at the device. Nevertheless, when assessing the measurement results one has to bear in mind that the results can be influenced by various factors:

- Performing the measurement
  - When the ball head is held to corners (e.g. window frames), the measured value is generally higher, because there is more matter in the measuring head's stray field. Toward a corner a distance of more than 8 to 10 cm has to be observed.
  - When performing the measurement, always hold the ball head perpendicular to the material to be measured. Press the ball head firmly against the surface to be measured and make sure not to tilt it.
- Measuring depth
  - Depending on the material's bulk density and degree of moisture penetration, the device's penetration depth ranges up to 40 mm. Conclusions regarding zones located at a lower level cannot be drawn.
- Material characteristics
  - Increased occurrences of soluble salts in the measured material can distort the result of the measurement. The more salts present, the higher the conductivity of the material and the higher will be the displayed measurement value.
  - If possible, do not measure wood with a temperature below  $-5\text{ }^{\circ}\text{C}$ . Too low wood temperatures distort the result of the measurement.
  - Material aggregates and their concentration, e.g. in screed or concrete, can also considerably influence the height of the measured value.
  - The material should be preferably homogenous and not have any air pockets.

- Electrically conducting materials or electrical fields
  - If a construction material contains electrically conducting substances, the dielectric constant is also increased, which then simulates high moisture values. Consequently, a too high measured value will be displayed.
  - If the material to be measured contains metal (e.g. nails, screws, lines, pipes, etc.) and is situated within the sensor's measuring field, the measured value skyrockets due to intense reflections.
  - From visual inspection it is not always apparent, whether there are any electrically conducting substances inside the construction material. Some of the main error sources here are in particular reinforcements, metal laminations and conducting insulation such as slag in timber beam ceiling constructions. Especially in case of insulation materials with metal lamination, measured values are often misinterpreted.
  - Avoid static charge of the material to be measured due to friction. Static charge distorts the measurement result.
  - With a wood moisture of less than 10 % RH, electrostatic forces may occur at the good to be measured. This can falsify the result of the measurement. Experience has shown that this occurs at the outlet of veneer drying plants. Remove the static charge by use of suitable grounding measures.
  - For optimum conditions neither electrical fields nor conducting materials should be present.
- Surface condition
  - Before measuring, the measuring point is to be cleared of any impurities (e.g. paint residues, dust).
  - Oily and/or aqueous timber preservatives affect the measurement result.
  - Rough surfaces will always result in a too low measured value.
  - The surface of the material to be measured should be as level as possible to permit thorough contact of the measuring probe.
- Moisture distribution
  - With material thicknesses of less than 2 cm there is a danger of humidity values from adjacent material layers affecting the measured value.
  - Ideally, the moisture should be evenly distributed within the material to be measured.

Quantitative conclusions about the moisture content of the mineral material to be measured can only be drawn by applying the Darr procedure or the CM method.

## Maintenance and repair

### Battery change

A battery change is required when the LED at the device flashes red or the device can no longer be switched on. See chapter Operation.

### Cleaning

Clean the device with a soft, damp and lint-free cloth. Make sure that no moisture enters the housing. Do not use any sprays, solvents, alcohol-based cleaning agents or abrasive cleaners, but only clean water to moisten the cloth.

### Repair

Do not modify the device or install any spare parts. For repairs or device testing, contact the manufacturer.

## Errors and faults

The device has been checked for proper functioning several times during production. If malfunctions occur nonetheless, check the device according to the following list.

### Bluetooth connection is terminated or interrupted

- Check whether the LED at the appSensor flashes green. If so, briefly switch it off completely, then turn it back on. Establish a new connection to the terminal device.
- Check the battery voltage and insert new or freshly charged batteries, if required.
- Does the distance between appSensor and terminal device exceed the appSensor's radio range (see chapter *Technical data*) or are there any solid building parts (walls, pillars etc.) situated between appSensor and terminal device? Shorten the distance between the two devices and ensure a direct line of sight.

### The sensor cannot be connected to the terminal device although it is displayed there.

- Check the Bluetooth settings of your terminal device. A possible reason for this could be special, manufacturer-specific settings relating to an improved location accuracy. Enable these settings, then try to establish a connection to the sensor again.

Further information and assistance regarding the used sensor type will be provided in the MultiMeasure Mobile app via the menu item Settings => *Help*. Selecting the menu item *Help* opens a link to the app's help page. You can open a drop-down menu with numerous support entries from the *Table of contents*. Optionally, you can also scroll through the entire help page and thoroughly acquaint yourself with the individual help topics.

## Disposal

Always dispose of packing materials in an environmentally friendly manner and in accordance with the applicable local disposal regulations.



The icon with the crossed-out waste bin on waste electrical or electronic equipment is taken from Directive 2012/19/EU. It states that this device must not be disposed of with the household waste at the end of its life. You will find collection points for free return of waste electrical and electronic equipment in your vicinity. The addresses can be obtained from your municipality or local administration. You can also find out about other return options that apply for many EU countries on the website <https://hub.trotec.com/?id=45090>. Otherwise, please contact an official recycling centre for electronic and electrical equipment authorised for your country.

The separate collection of waste electrical and electronic equipment aims to enable the re-use, recycling and other forms of recovery of waste equipment as well as to prevent negative effects for the environment and human health caused by the disposal of hazardous substances potentially contained in the equipment.



In the European Union, batteries and accumulators must not be treated as domestic waste, but must be disposed of professionally in accordance with Directive 2006/66/EC of the European Parliament and of the Council of 6 September 2006 on batteries and accumulators. Please dispose of batteries and accumulators according to the relevant legal requirements.

### Only for United Kingdom

According to Waste Electrical and Electronic Equipment Regulations 2013 (SI 2013/3113) (as amended) and the Waste Batteries and Accumulators Regulations 2009 (SI 2009/890) (as amended), devices that are no longer usable must be collected separately and disposed of in an environmentally friendly manner.

## Declaration of conformity

We – Trotec GmbH – declare in sole responsibility that the product designated below was developed, constructed and produced in compliance with the requirements of the EU Radio Equipment Directive in the version 2014/53/EU.

**Product model / Product:** BM31WP  
**Product type:** material moisture measuring device controlled via smartphone  
**Year of manufacture as of:** 2019

### Relevant EU directives:

- 2001/95/EC
- 2014/30/EU

### Applied harmonised standards:

- EN 300 328 V2.2.2
- EN 61326-1:2013

### Applied national standards and technical specifications:

- EN 301 489-1 Draft Version 2.2.0:2017-03
- EN 301 489-17 Draft Version 3.2.0:2017-03
- EN 61010-1:2010
- EN 62479:2010

### Manufacturer and name of the authorised representative of the technical documentation:

Trotec GmbH  
Grebbener Straße 7, D-52525 Heinsberg  
Phone: +49 2452 962-400  
E-mail: [info@trotec.de](mailto:info@trotec.de)

Place and date of issue:  
Heinsberg, 17.02.2023



Joachim Ludwig, Managing Director

Trotec GmbH

Grebener Str. 7  
D-52525 Heinsberg

☎ +49 2452 962-400

☎ +49 2452 962-200

✉ [info@trotec.com](mailto:info@trotec.com)

[www.trotec.com](http://www.trotec.com)